

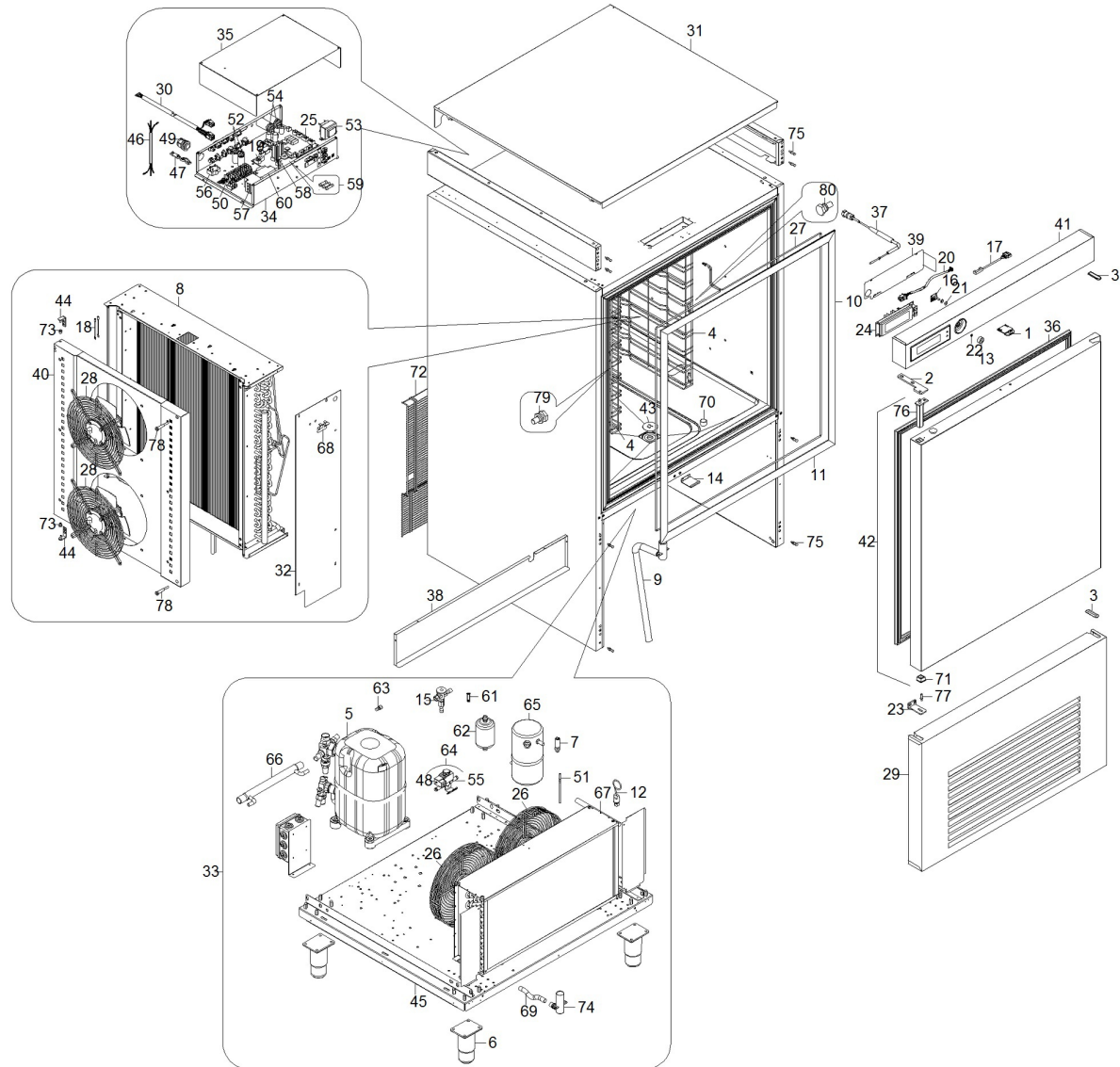

























































2
HOME / REFRIGERATION / BLAST CHILLERS AND FREEZERS GN / XS72S / 2







	Modification	   Code	  Description	  Rec.	Price  	Qty Validity date
		1 3065480	SUPPORT		4,19	1 21/09/2015-
		2 3082260	TOP BRACKET		12,12	1 21/09/2015-
		3 3082370	HOLE PLUG		2,78	2 21/09/2015-
		4 3129410	RACK		0,00	2 21/09/2015-
		5 3129470	COMPRESSOR R404A (BT)		0,00	1 21/09/2015-
		6 3137690	FOOT	X	20,53	4 21/09/2015-
		7 3142560	VALVE		0,00	1 21/09/2015-
		8 3149580	EVAPORATOR	X	1566,36	1 21/09/2015-
		9 3171400	DRAIN	X	35,75	1 21/09/2015-
		10 3187120	FRAME TRIM		0,00	2 21/09/2015-
		11 3187130	FRAME TRIM		0,00	2 21/09/2015-
		12 3185180	PRESSURE-SWITCH	X	63,78	1 21/09/2015-
		13 3188430	KNOB		9,59	1 21/09/2015-
		14 3192300	BRACKET		0,00	1 21/09/2015-
		15 3204640	THERMOST. VALVE	X	373,21	1 21/09/2015-
		16 3205790	ENCODER	X	36,38	1 21/09/2015-
		17 3221440	MICROSWITCH	X	34,11	1 21/09/2015-
		18 3221720	POROBE NTC	X	26,28	1 21/09/2015-02/02/2022
		19 3226760	PART.MODULE	X	104,90	1 21/09/2015-14/01/2018
		20 3226810	CABLE	X	36,70	1 21/09/2015-

	Modification	 ↑↓ Code	↑↓ Description	↑↓ Rec.	Price ↑↓	Qty Validity date
		21 3235850	WASHER		0,68	2 21/09/2015-
		22 3235890	O-RING		0,62	1 21/09/2015-
		23 3252280	BOTTOM BRACKET	X	47,03	1 21/09/2015-
		24 3252300	VIDEO BOARD	X	456,22	1 21/09/2015-14/01/2018
		25 3260850	ELECTRONIC CARD	X	432,81	1 21/09/2015-14/01/2018
		26 3277020	FAN MOTOR	X	295,94	2 21/09/2015-
		27 3279910	RESISTOR	X	51,08	1 21/09/2015-
		28 3280180	EVAPORATOR FAN	X	620,84	2 21/09/2015-
		29 3306020	PROTECTION		0,00	1 07/07/2016-
		30 3280630	CABLE		0,00	1 21/09/2015-
		31 3280730	LOCK PANEL		94,64	1 21/09/2015-
		32 3280740	RISER		0,00	1 21/09/2015-
		33 3282810	MOTOR UNIT		0,00	1 21/09/2015-
		34 3284820	PANEL BOARD		0,00	1 21/09/2015-14/01/2018
		35 3284990	COVER		0,00	1 21/09/2015-
		36 3286060	GASKET	X	70,80	1 21/09/2015-10/01/2018
		36 3346480	GASKET	X	50,82	1 11/01/2018-
		37 3287150	PIN PROBE	X	316,98	1 21/09/2015-
		38 3292450	LOCK PANEL		0,00	1 21/09/2015-
		39 3292810	CARD PROTECTION		0,00	1 21/09/2015-

	Modification	   Code	  Description	  Rec.	Price  	Qty Validity date
		40 3293290	EVAP. GUARD		0,00	1 21/09/2015-
		41 6039860	FRONT PANNEL		273,97	1 21/09/2015-
		42 6039870	DOOR UNIT		0,00	1 21/09/2015-
		43 30G3710	PLUG		17,39	1 21/09/2015-
		44 30T2690	BRACKET		17,05	2 21/09/2015-
		45 30W5100	TRAY X ASSEMBLY		0,00	1 21/09/2015-
		46 32A1960	POWER SUPPLY CABLE		0,00	1 21/09/2015-
		47 32D0020	CABLE CLAMP		23,08	1 21/09/2015-
		48 32D0710	THREE-POLE CONN.		0,00	1 21/09/2015-
		49 32D1590	CABLE CLAMP		0,00	1 21/09/2015-
		50 32D1750	TERMINAL BOARD		24,91	1 21/09/2015-
		51 32V3730	POROB E NTC	X	19,43	1 21/09/2015-
		52 32V4640	CONDENSER	x	0,00	2 21/09/2015-
		53 32V5770	TRANSFORMER	X	43,01	1 21/09/2015-14/01/2018
		54 32V7680			0,00	2 21/09/2015-
		55 32Z2750	COIL	X	52,54	1 21/09/2015-
		56 32Z8440	FILTER	X	27,27	1 21/09/2015-14/01/2018
		57 32Z9250	SWITCH	X	100,45	1 21/09/2015-
		58 32Z9500	FUSE-HOLDER		0,00	3 21/09/2015-
		59 32Z9520	FUSE	X	4,62	3 21/09/2015-

	Modification	   Code	  Description	  Rec.	Price  	Qty Validity date
		60 32Z9880	RELAY	X	101,23	1 21/09/2015-
		61 33A0300	BORE	X	61,24	1 21/09/2015-
		62 33A0600	FILTER		48,36	1 21/09/2015-
		63 33A1200	AUXIL.VALVE		7,52	2 21/09/2015-
		64 3266070	VALVE		0,00	1 21/09/2015-
		65 33G1170	DRIP TRAY		124,61	1 21/09/2015-
		66 34D7590	COOLER		0,00	1 21/09/2015-
		67 34D8790	CONDEN.+BAFFLE	X	892,22	1 21/09/2015-
		68 35C9840	PROBE SUPPORT		0,00	1 21/09/2015-
		69 35X1640	DRAIN TRAP	X	6,86	1 21/09/2015-
		70 36C2690	PIN		0,00	4 21/09/2015-
		71 36C5620	PLUG	X	3,85	1 21/09/2015-
		72 36C5710	PROTECT GRID		0,00	1 21/09/2015-
		73 36E0410	BUSHING	x	4,85	2 21/09/2015-
		74 36E2510	CONDENS. DRAIN	X	4,46	1 21/09/2015-
		75 36G1140	PIN		7,12	8 21/09/2015-
		76 36G6520	HINGE	X	23,08	1 21/09/2015-
		77 36G9410	PIN	X	10,78	1 21/09/2015-
		78 36M7440	HANDLE	X	9,17	2 21/09/2015-
		79 36M7820	PIN		0,00	6 21/09/2015-

2
[HOME](#) / [REFRIGERATION](#) / [BLAST CHILLERS AND FREEZERS GN](#) / [XS72S](#) / 2

	Modification	   Code	  Description	  Rec.	Price  	Qty Validity date
		80 36G7420	PIN		9,38	6 21/09/2015-